

TECHNICAL CATALOGUE

**Floor convectors
for humid
conditions
TK-S-13 with
natural convection**

We care about healthy air

Floor convector for humid conditions with natural convection TK-S-13

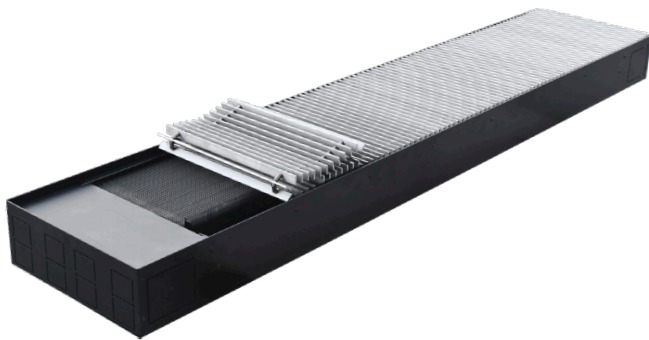

TK-S-13 floor convectors for humid conditions with natural convection

Natural convection floor convectors are designed for secondary room heating with heating capacities up to 1.7 kW. They are particularly suitable for heating of areas with increased level of humidity such as swimming pools or similar.

Application

Setting up into the room and installation is the same as for floor convectors TK-13. They are used for heating, prevention of condensation on glass surfaces, reduction of the convection effect from cold surfaces, and prevention of ingress of cold outside air. Because of the potential ingress of water into the interior of the housing, collection tray is mounted to collect and drain water, but we do not recommend installing floor convectors in direct proximity to swimming pools, hot tubs, ... (recommended distance > 1 m), or in a place with the greater possibility of water ingress of water into the convector's housing.

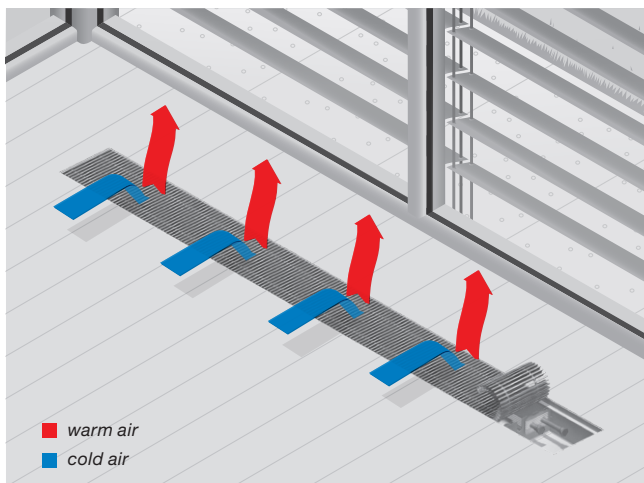

Components

Basic design:

1. Heat exchanger
2. Tread-on grille
3. Water collection drip tray
4. Housing

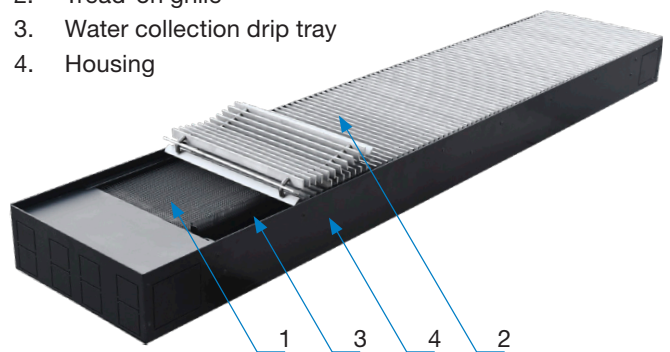

Dimensions

- Standard widths: 200, 300, 400 mm
- Standard height: 140 mm
- 18 standard lengths: from 800 mm to 2500 mm.

Accessories

Water side regulation is possible with manual valves 01-04 only.

Selection

User friendly selection software makes it easy to select the optimum floor convector for individual projects.

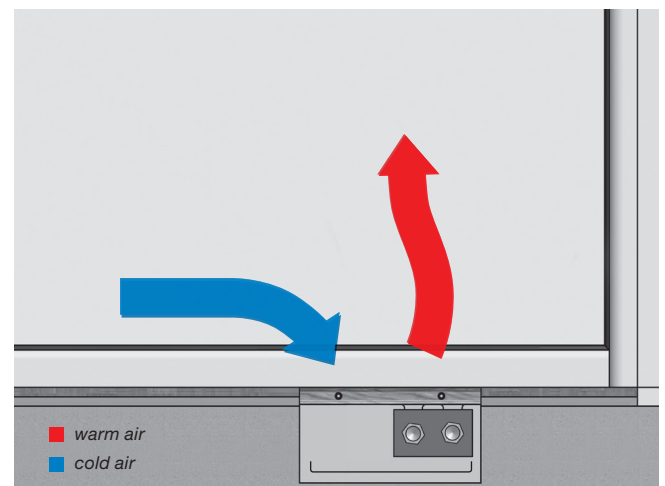

Technical data

TK-S-13 Lx20x14

Housing length L [mm]	Heating capacity								
	75 °C / 65 °C / 20 °C			90 °C / 70 °C / 20 °C			55 °C / 45 °C / 20 °C		
	Q_h	\dot{m}_w	Δp_w	Q_h	\dot{m}_w	Δp_w	Q_h	\dot{m}_w	Δp_w
	[W]	[kg/h]	[kPa]	[W]	[kg/h]	[kPa]	[W]	[kg/h]	[kPa]
800	163	14.0	<0.01	204	8.8	<0.01	75	6.5	<0.01
900	203	17.5	<0.01	255	11.0	<0.01	94	8.1	<0.01
1000	244	21.0	<0.01	306	13.2	<0.01	113	9.7	<0.01
1100	285	24.5	<0.01	357	15.3	<0.01	132	11.3	<0.01
1200	326	28.0	0.01	408	17.5	<0.01	150	12.9	<0.01
1300	366	31.5	0.01	459	19.7	<0.01	169	14.5	<0.01
1400	407	35.0	0.01	510	21.9	<0.01	188	16.1	<0.01
1500	448	38.5	0.02	561	24.1	0.01	207	17.8	<0.01
1600	488	42.0	0.02	612	26.3	0.01	225	19.4	<0.01
1700	529	45.4	0.03	663	28.5	0.01	244	21.0	0.01
1800	570	48.9	0.03	714	30.7	0.01	263	22.6	0.01
1900	610	52.4	0.04	765	32.9	0.02	282	24.2	0.01
2000	651	55.9	0.05	816	35.1	0.02	301	25.8	0.01
2100	692	59.4	0.06	867	37.3	0.02	319	27.4	0.01
2200	732	62.9	0.07	918	39.5	0.03	338	29.1	0.01
2300	773	66.4	0.08	969	41.6	0.03	357	30.7	0.02
2400	814	69.9	0.09	1021	43.8	0.04	376	32.3	0.02
2500	854	73.4	0.11	1072	46.0	0.04	395	33.9	0.02

Q_h [W]: Heating capacity \dot{m}_w [kg/h]: Water flow Δp_w [kPa]: Pressure drop on the water side

Technical data

TK-S-13 Lx30x14

Housing length L [mm]	Heating capacity								
	75 °C / 65 °C / 20 °C			90 °C / 70 °C / 20 °C			55 °C / 45 °C / 20 °C		
	Q_h	\dot{m}_w	Δp_w	Q_h	\dot{m}_w	Δp_w	Q_h	\dot{m}_w	Δp_w
	[W]	[kg/h]	[kPa]	[W]	[kg/h]	[kPa]	[W]	[kg/h]	[kPa]
800	217	18.7	0.00	266	11.4	0.00	108	9.2	0.00
900	272	23.4	0.01	333	14.3	0.00	134	11.5	0.00
1000	326	28.0	0.01	399	17.2	0.00	161	13.9	0.00
1100	381	32.7	0.01	466	20.0	0.01	188	16.2	0.00
1200	435	37.4	0.02	532	22.9	0.01	215	18.5	0.01
1300	489	42.0	0.03	599	25.7	0.01	242	20.8	0.01
1400	544	46.7	0.04	665	28.6	0.02	269	23.1	0.01
1500	598	51.4	0.06	732	31.4	0.02	296	25.4	0.01
1600	653	56.1	0.07	798	34.3	0.03	323	27.7	0.02
1700	707	60.7	0.09	865	37.2	0.03	349	30.0	0.02
1800	761	65.4	0.11	932	40.0	0.04	376	32.3	0.03
1900	816	70.1	0.14	998	42.9	0.05	403	34.6	0.03
2000	870	74.7	0.17	1065	45.7	0.06	430	37.0	0.04
2100	924	79.4	0.20	1131	48.6	0.08	457	39.3	0.05
2200	979	84.1	0.24	1198	51.5	0.09	484	41.6	0.06
2300	1033	88.8	0.28	1264	54.3	0.11	511	43.9	0.07
2400	1088	93.4	0.33	1331	57.2	0.12	538	46.2	0.08
2500	1142	98.1	0.38	1397	60.0	0.14	564	48.5	0.09

Q_h [W]: Heating capacity \dot{m}_w [kg/h]: Water flow Δp_w [kPa]: Pressure drop on the water side

Technical data

TK-S-13 Lx40x14

Housing length L [mm]	Heating capacity								
	75 °C / 65 °C / 20 °C			90 °C / 70 °C / 20 °C			55 °C / 45 °C / 20 °C		
	Q_h	\dot{m}_w	Δp_w	Q_h	\dot{m}_w	Δp_w	Q_h	\dot{m}_w	Δp_w
	[W]	[kg/h]	[kPa]	[W]	[kg/h]	[kPa]	[W]	[kg/h]	[kPa]
800	261	22.4	0.01	316	13.6	0.00	132	11.4	0.00
900	326	28.0	0.01	395	17.0	0.00	165	14.2	0.00
1000	391	33.6	0.02	474	20.4	0.01	198	17.0	0.01
1100	456	39.2	0.03	553	23.8	0.01	231	19.9	0.01
1200	522	44.8	0.05	633	27.2	0.02	265	22.7	0.01
1300	587	50.4	0.07	712	30.6	0.02	298	25.6	0.02
1400	652	56.0	0.09	791	34.0	0.03	331	28.4	0.02
1500	717	61.6	0.12	870	37.4	0.04	364	31.3	0.03
1600	783	67.2	0.15	949	40.8	0.06	397	34.1	0.04
1700	848	72.8	0.20	1028	44.2	0.07	430	36.9	0.05
1800	913	78.4	0.24	1107	47.6	0.09	463	39.8	0.06
1900	978	84.0	0.30	1186	50.9	0.11	496	42.6	0.08
2000	1043	89.6	0.36	1265	54.3	0.13	529	45.5	0.09
2100	1109	95.2	0.44	1344	57.7	0.16	562	48.3	0.11
2200	1174	100.8	0.52	1423	61.1	0.19	595	51.1	0.13
2300	1239	106.5	0.61	1502	64.5	0.22	628	54.0	0.16
2400	1304	112.1	0.71	1581	67.9	0.26	661	56.8	0.18
2500	1369	117.7	0.82	1660	71.3	0.30	694	59.7	0.21

Q_h [W]: Heating capacity \dot{m}_w [kg/h]: Water flow Δp_w [kPa]: Pressure drop on the water side

Dimensions

TK-S-13 Lx20x14

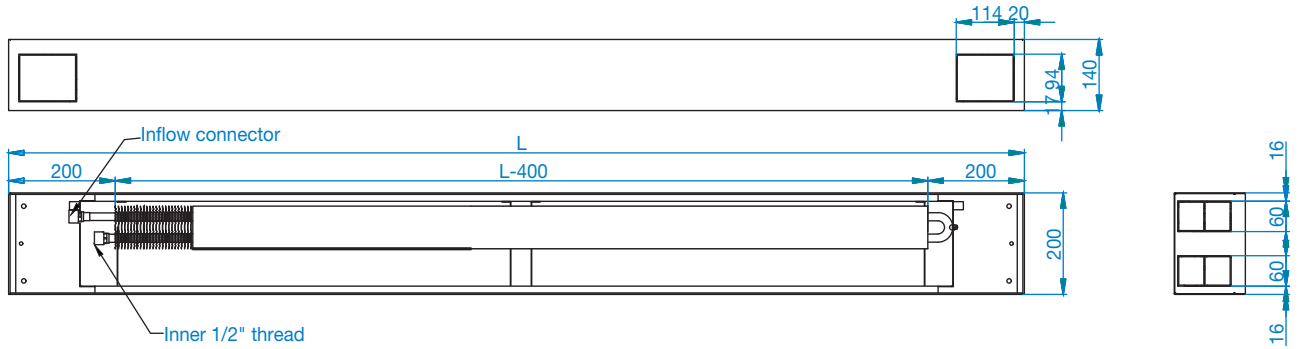

TK-S-13 Lx30x14

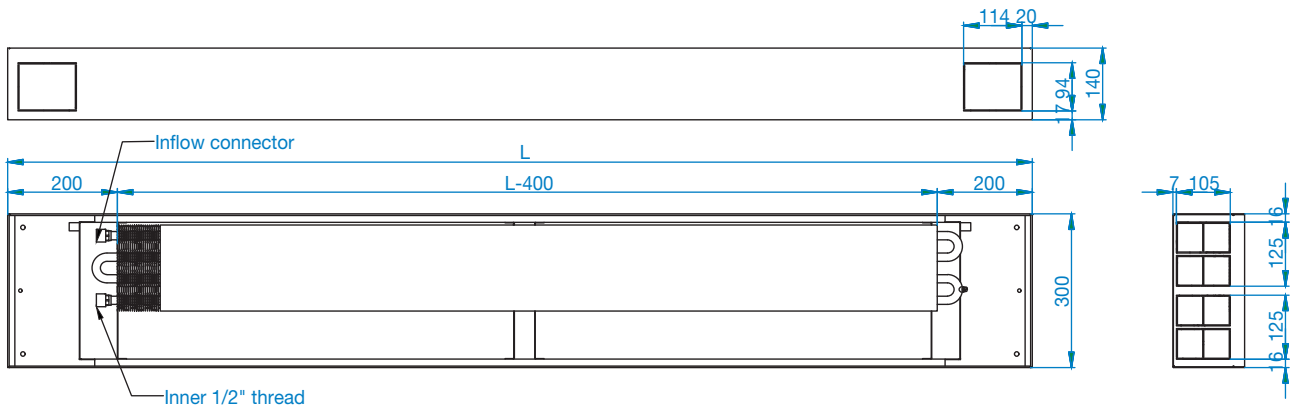

TK-S-13 Lx40x14

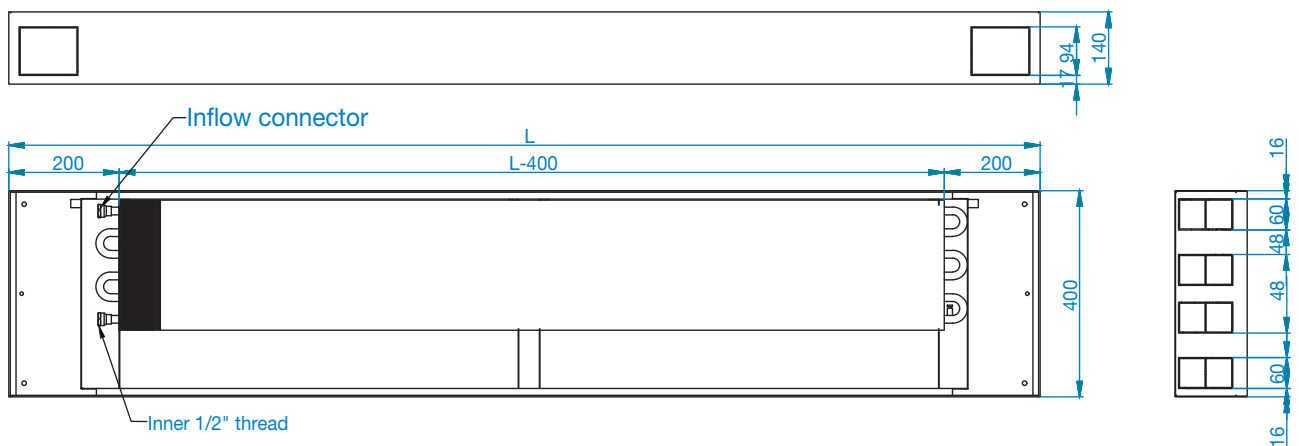

Quick overview of floor convectors TK-S-13

Basic characteristics

Heating capacities	up to 1.7 kW
Length	800 – 2500 mm, increment 100 mm
Width	200, 300, 400 mm
Height	140 mm

Dimensions

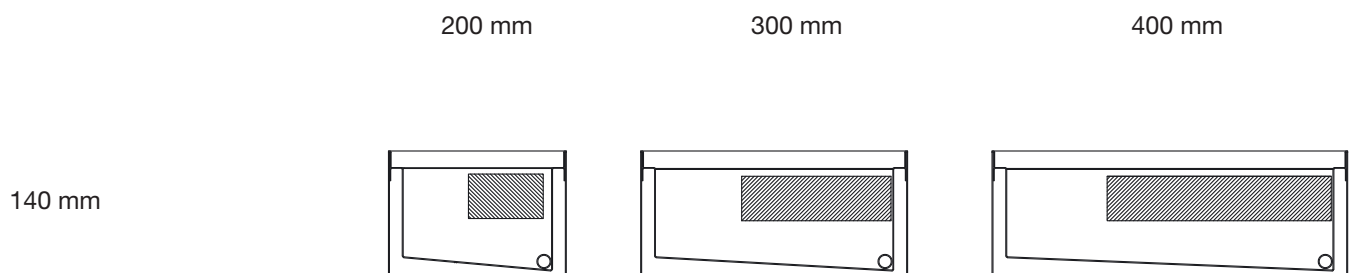

Accessories

Code	Tread-on grille	
111	Standard tread-on grille design: longitudinal fixed aluminium grille	Anodised aluminium natural aluminium colour, black, brass colour, chocolate, bronze*
114	roll-up aluminium grille	Anodised aluminium natural aluminium colour, black, brass colour, chocolate, bronze
114W	roll-up wooden grille	Wood type oak, ash, walnut, mahogany, wenge, cherry
114SS	roll-up steel	Stainless steel

*For longitudinal grilles other grille colors acc. RAL scale are available on customer's request.

Code	Control accessories
	Water side control (control of the warm water flow rate into the convector)
01	Manual valve R1/2", straight
02	Manual valve R1/2", angular
03	Radiator shut-off cock R1/2", straight
04	Radiator shut-off cock R1/2", angular

Code	Other accessories
010(xx°)*	Corner design of convector and grille
017	Housing thermal insulation
018	Wooden protection cover (protection of the convector during the installation)
021	Aluminium frame, fixed to the housing
028	Level adjusting legs, levelling height 20-70 mm
029	Level adjusting and support legs, with reinforced housing (upon request)
032	Connection for fresh air supply, without damper (upon request)
033	Connection for fresh air supply, with damper (upon request)
040	Lowered side

*(xx°) = state desired angle, e.g. 90 °

Types and colours of tread-on grilles

Longitudinal tread-on grilles are designed to withstand the weight of an individual person, while in case of larger loads roll-up grilles are recommended.

Longitudinal aluminium tread-on grilles

111D longitudinal fixed grille, anodised in natural aluminium colour



111B longitudinal fixed grille, anodised in black colour



111C longitudinal fixed grille, anodised in brass colour



111E longitudinal fixed grille, anodised in chocolate colour



111F longitudinal fixed grille, anodised in bronze colour



Aluminium and stainless steel roll-up grilles

114D roll-up grille, anodised in natural aluminium colour

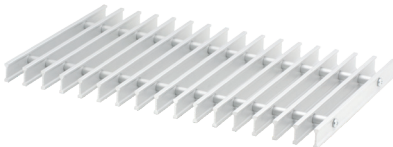

114B roll-up grille, anodised in black colour

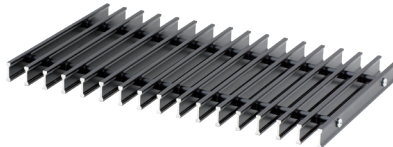

114C roll-up grille, anodised in brass colour

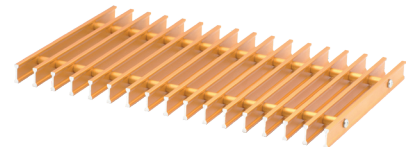

114E roll-up grille, anodised in chocolate colour



114F roll-up grille, anodised in bronze colour



114SS roll-up grille, stainless steel

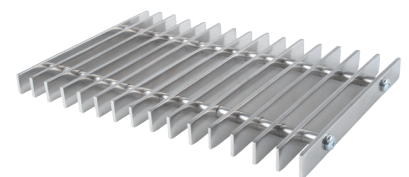

Wooden roll-up grilles

114W1 oak wood

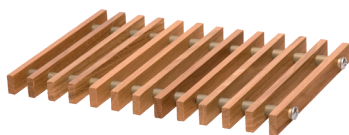

114W2 ash wood

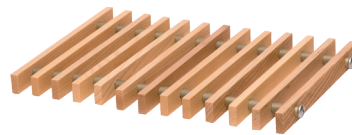

114W3 walnut wood

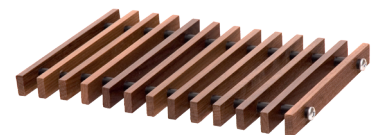

114W4 mahogany wood

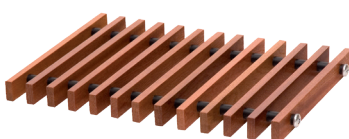

114W5 wenge wood

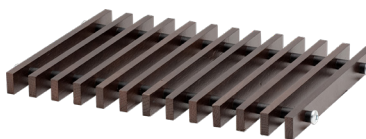

114W6 cherry wood

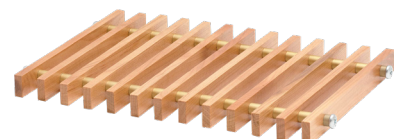

Water side control accessories

01 Manual valve R1/2", straight



03 Radiator shut-off cock R1/2", straight

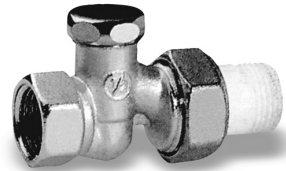

02 Manual valve R1/2", angular



04 Radiator shut-off cock R1/2", angular

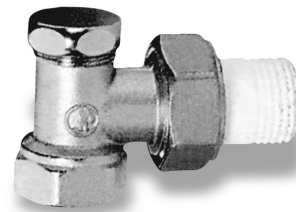

Notes:

- Manual valves 01-04 are only supplied with the convector but not installed.

Other accessories

010(xx°) Corner design of convector and grille

According to drawing.

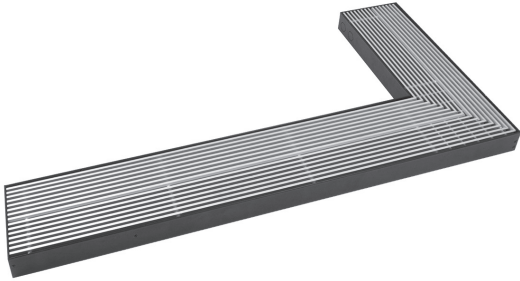

017 Housing thermal insulation



018 Wooden protection cover

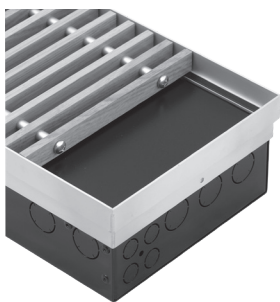
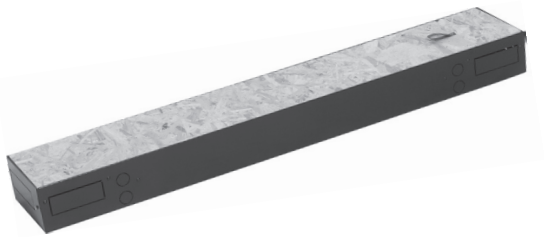

021 Aluminium frame

Note:
when ordering
accessory 021,
length and width of
housing increase for
12 mm. The length
and width of the
grille also change
accordingly.

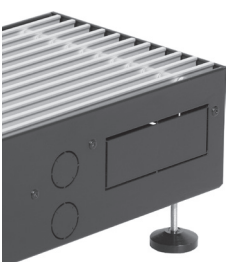
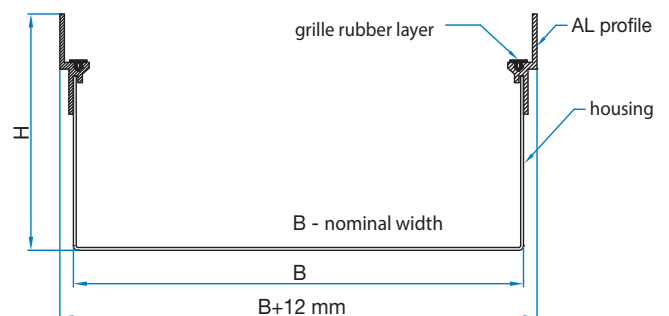

028 Level adjusting legs

- Levelling height (distance to the bottom of floor convector) is 20–70 mm.
- Installation possible in models of 105 and 140 mm height only.
- Different project solutions upon request.



029 Level adjusting and support legs

- Recommended for installation into false floor.
- Set with reinforced housing bracket.
- Available upon request.

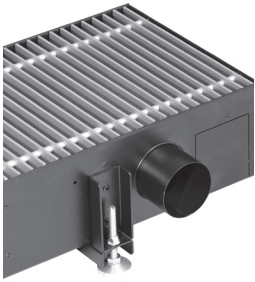

032 Connection for fresh air supply without damper

- The connection for fresh air supply is available as a tailored solution, installation details, connection placement and size are to be clarified with the producer for each project individually.

033 Connection for fresh air supply with damper

- The connection for fresh air supply is available as a tailored solution, installation details, connection placement and size are to be clarified with the producer for each project individually.

Example of TK-S-13 convector with fresh air supply

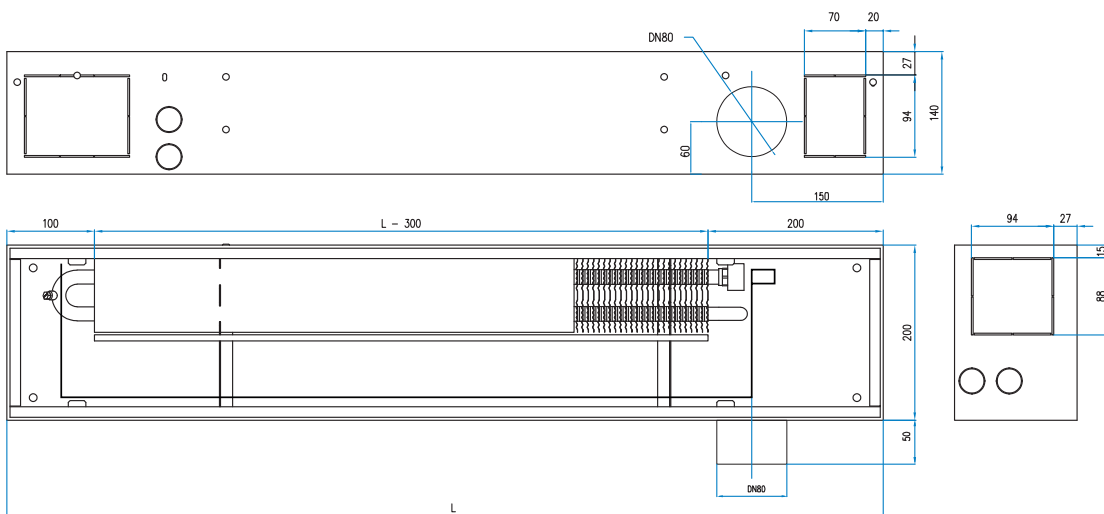

Special versions

Custom-made floor convectors with non-standard dimensions and technical characteristics can be produced on customer's request and according project specifications.

040 Lowered side

- For connecting two or more floor convectors in line. The grille is from one piece limited with maximum grille length.
- Possible lowered side on the right 040R, lowered side on the left 040L, both lowered sides 040R, 040L.

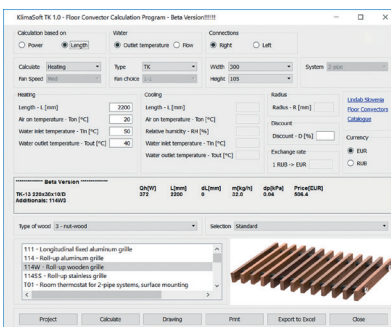

For selection of floor convectors user friendly software is available on request.

Ordering key

TK-S-13 200 X 20 X 14 / R / N / 01,03 / / 111D / /

1 2a x 2b x 2c 3 4 5 6 7 8

1 Type

TK-S-13 Floor convector with natural convection for humid conditions

2 Floor convector length

080-250 800 – 2500 mm (increment 100 mm)

2b Width

20 200 mm

30 300 mm

40 400 mm

2c Height

14 140 mm

3 Water connection side

R Right (convector seen from the room towards the window)

L Left (convector seen from the room towards the window)

4 New floor conector version 2017

N New generation of floor convectors with optimized technical characteristics and price:performance ratio.

5 Valve type

01 Manual valve, straight

02 Manual valve, angular

03 Shut-off cock, straight

04 Shut-off cock, angular

6 Special housing designs

010(xx°) Corner design (example: angle xx°= 90°)

7 Grille

111 Longitudinal aluminium grille, anodised

114 Roll-up aluminium grille, anodised

114W Wooden roll-up grille

114SS Stainless steel roll-up grille

8 Accessories

017 Housing thermal insulation

018 Wooden protection cover for increased protection during installation

021 Aluminium decorative frame fixed to the housing

028 Level adjusting legs

029 Level adjusting and support legs, with reinforced housing

032 Fresh air connection without damper

033 Fresh air connection with damper

040R Lowered side on the right

040L Lowered side on the left

Product description, scope of delivery, dimensions

Floor convectors with natural convection TK-S-13

Housing

- Housing suitable for false floor installation, installation in concrete floors or screed. Operation principle: natural convection.
- The durable, stable box is made of steel sheet powder painted in black color (RAL 9005).
- The adjustable support screws are located inside the housing. Optionally, also support legs mounted outside of the housing are available to increase the housing stability (accessory 029). The support surfaces for the decorative grille in the housing are equipped with a special anti-slip seal that ensures good sound insulation and fit of the grille.
- The connections can be carried out on both side and front housing panel.
- Water collection drip tray included as standard.

Heat exchanger

- The heat exchanger consists of copper pipes and aluminum fins in natural aluminium color and is placed in the housing on steel support brackets.
- Features:
 - End connection;
 - Inner thread ½"
 - Fitted with a de-airing valve;
 - Suitable for operation with a maximum working pressure of 11 bar (maximum allowed pressure 16 bar) and maximum operating temperature 110 °C.

Grille

- As standard, a longitudinal aluminum grille is delivered with the floor convector (the price can be given separately). The grille is placed on an antivibration sealing tape for improved sound attenuation. The grille itself consist of 18 mm high profile rods, anodized in natural aluminum color. The effective cross-section is approx. 70%. Since the grille is made of I-profiles it can be turned over and used equally on both sides.

Standards

- Heating characteristics are measured acc. European standard EN 442.
- Quality management system according to standard EN ISO 9001
- Environmental management system according to standard EN ISO 14001

Dimensions

- Natural convection floor convectors apply the principle of natural circulation of air, caused by temperature differences.
- Cold air enters into the floor convector, is warmed up in the heat exchanger and rises into the room.

Application

- Floor convectors are used as an efficient heating solution for premises with humid conditions and large glazing envelope surfaces such as swimming pools, spa areas, etc.

Scope of delivery

- 3 convector widths: 200, 300, 400 mm;
- 1 convector height: 140 mm;
- 18 convector lengths: from 800 mm to 2500 mm length (increment is 100 mm)

Accessories

- See description on pages 10.



OC IMP Klima d.o.o
Godovič 150
SI - 5275 Godovič

T: +386 5 3743 000
e info@oc-impklima.com